

USER MANUAL

Thank you for choosing the EPOWER! Always follow basic safety precautions when using electrical appliances. Read all instructions carefully, Please keep this instruction manual for easy reference

A. PRODUCT LAYOUT :

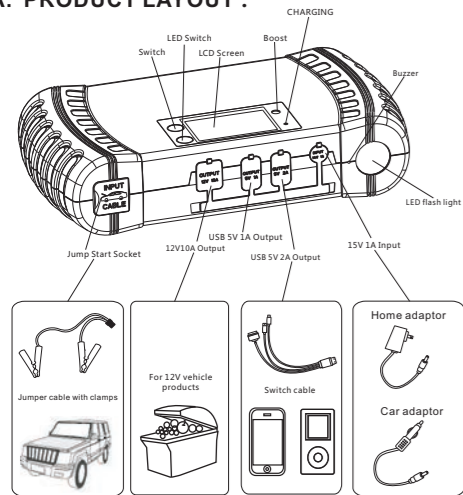

①

B. OPERATION GUIDANCE

LCD Display Description:

1. The power display:

Press switch button , display "BATTERY", also shows the host power. Show XX%, indicating that the battery has a XX% of the electricity; Show Fu, said that full power; display "BATTERY LOW RECHARGE", indicates that EPOWER power is low, please charge.

2. The products charge

EPOWER connected to home or car charger charge, "CHARGING" light indicates charging, charging display "CHARGING", and displays the current EPOWER is charged with electricity.

3. LED lighting display

Tap EPOWER master light switch  can be turned on and off in different lighting modes, as follows: lighting modes: Show LIGHT; Strobe Mode: Displays FLASH; SOS distress mode: the SOS closed.

4. each output is displayed:

5V1A/2A USB1(2) output: When 5V1A/2A USB1(2) output port connected to the USB cable and press the power switch , the display usb1(2), then you can give mobile phones, tablet computers and other digital products charge.

12V10A DC Output: When 12V10A connected to DC adapter cable and press the power switch , which was 12V10A, can supply to 12V automotive electronics products.

12V car boot: equipped with a battery clip, blue plug into the host-initiated interface, connect the red clip battery positive, black clip connect the battery negative.

When the LCD will appear "SHORT CIRCUIT IN JUMPING PORT", it indicates a short circuit when the battery clip, this time should be banned to start, unplug the battery clip, and sent professionals to inspect.

When the LCD will appear "WARNING CLAMPS REVERSED", it means that when the battery clip to connect the battery positive and negative error., this time prohibited by BOOST, please reconnect your battery clip.

When the LCD displays "BATTERY LOW RECHARGE", indicates that EPOWER power is low, then the charge should be made after EPOWER startup.

When the LCD displays "JUMP START READY", indicates battery clip connected correctly, you can start to operate;

When the LCD displays "PRESS BOOST BUTTON", indicates battery clip is properly connected, then press BOOST button to complete the boot operation within 30S.

CHARGING BATTERY LIGHT SOS

 BATTERY LOW RECHARGE
 JUMP START READY
 WARNING CLAMPS REVERSED
 SHORT CIRCUIT IN JUMPING PORT

Show renderings

②

EPOWER Charging Instruction :

1. Plug the home adaptor into the universal socket.
2. Connect 15V 1A input port of EPOWER to the other end of home adaptor .

Or

1. Plug the car adaptor into the socket of cigarette lighter.
2. Connect 15V 1A input port of EPOWER to the other end of car adaptor.

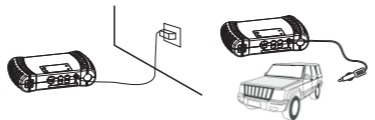

Jump start 12V gasoline vehicle Instruction:

1. Make sure that the number of indicators is not less than 60%.
2. Connect the RED clamp to the vehicle's battery positive (+) terminal and connect the BALCK clamp to the vehicle's battery negative (-) terminal.
3. Plug the cord of jumper cable into the jump start socket.
4. Start the vehicle
5. When the vehicle is started, remove jumper cable from EPOWER and disconnect red and black clamps to the vehicle battery terminals.
6. Leave the vehicle's engine running



Charging Cell Phone or Tablet Instruction:

1. Plug the switch cable B to USB 5V output port.

③

2. Select appropriate connector for your cell phone or tablet and connect it to any of them
3. Press the switch button to charge



For power supply to 12V vehicle products or 12V electronics

1. Plug the optional switch cable to 12V 10A output port.
2. Connect the optional switch cable and 12V vehicle product or 12V electronics.
3. Press the switch button to power supply.

C. PARTS LIST :

#	Parts Name	Quantity	#	Parts Name	Quantity
1	Host	1	4	Car adaptor	1
2	Mobile phone connector	1	5	Jumper cable with clamps	1
3	Home adaptor	1	6	User Manual	1

D. TECHNICAL SPECIFICATIONS :

Size : 186*93*42mm
Weight : 650g
Battery Capacity: 15000mAh(55.5Wh)
Output: 5V≐1A;5V≐2A;12V≐10A
Input : 15V --1A
Full charging time : 5 hours
Starting current : 250A
Peak current : 500A
Operating temperature : -20°C ~ 60°C

④

E. FAQ :

Q. How to turn off this appliance?

A. This appliance will power off automatically when no load or charging is complete

Q. How long time to full charge the Epower?

A. Approx. 5 hours through the 15V1A input.

Q. How many times can this appliance charge for my cell phone?

A. Approx. 6 times for iPhone6.

Q. How many times can this appliance jump start the vehicle if it is in full battery?

A. Approx. 25 times.

Q. What's the lifetime of EPOWER?

A. Usually 3-5 years in normal condition.

Q. How long the storage of battery will remain?

A. 6-12 months, however, we suggest to recharge it every 3 months.

F. TROUBLE SHOOTING:

Finding	Cause	Remedies
No response when pressing the switch button.	Low voltage protection of EPOWER is started.	Plug the adaptor into the 15V 1A input port to activate.

G. TOXIC AND HARMFUL SUBSTANCES:

Composition and amount of toxic and harmful substances in EPOWER					
Pb	Hg	Cd	Cr(VI)	PBB	PBDE
○	○	○	○	○	○

○ : Indicate all homogeneous materials' hazardous substances content are below the MCV limit specified in the Standard 2002/95/EC(RoHS).

⑤

H. Warning:

1. Always make sure the blue plug of jumper cable connect with the jump start socket tight in EPOWER before jumping start the vehicle. Otherwise, it will affect the results, even causing the melt of the blue plug.

2. Normally, DO NOT press the "BOOST" key when the jumper cable is connected to the host.

3. DO NOT connect the two clamps or connect to wrong battery terminals if the indicator is light on, otherwise maybe lead damage.

4. Always check if the jumper clamps are well connected, check if the vehicle battery connector is rusted or dirty, clean it before jumping start the vehicle. DO NOT jump start again after 3 attempts. Otherwise, it will damage the host. And Check your vehicle if it has other trouble.

 Always take care the appliance while using it.

 Do not use by any child or infant

 Do not use as a toy

 Do not allow the appliance to become wet

 Do not immerse the appliance in water

 Do not operate the appliance in explosive atmospheres, such as in the presence of flammable liquids, gases or dust

 Do not modify or disassemble EPOWER. Only a repair technician may repair this unit

 Do not expose the appliance to heat

 Do not store in locations where the temperature may exceed 70 °C

 Only Charge it at ambient temperatures between 0 °C and 40 °C

 Only Charge it with the charger provided with the appliance

 Under extreme conditions, battery leakage may occur. Carefully wipe the liquid off with cloth, and Please avoid skin contact when you notice liquid on the batteries. In case of skin or eye contact, rinse immediately with clean water and seek medical attention

 At the end of their useful life, discard the appliance with due care for our environment

⑥

I. WARRANTY INFORMATION:

1. We offer a limited warranty for this product against any defects in material and workmanship. The conditions of the warranty are as follows:

2. The warranty is only valid upon presentation of the original receipt (from dealer/retailer) by the original purchaser with the product to be repaired or replaced

3. The warranty is void if the serial number, date of purchase and label has been removed

4. The warranty does not cover damage or product failure resulting from normal wear and tear, physical abuse, improper installation, misuse, modification or repairs by unauthorized third parties

5. We do not assume responsibility for any loss or damage incurred during shipment or as a result of a force majeure

6. We are not liable for any incidental or consequential damages arising from the use or misuse of this product

7. All warranty claims are limited to repair or replacement of the defective product and at the sole discretion of us

8. If we repair or replace the product, the product will be covered for the remaining time of the original warranty period. Repair or replacement may involve the use of reconditioned units which are equivalent in function. Replaced part or product becomes the property of us

9. Consumable components such as batteries are not covered by the warranty

The switch cables coming with the unit for testing ONLY, no commercial value, all rights reserved for the original designed company.



Overcharge and Overdischarge Protection



Fuse Protection



Against-reverse Plug

Applied Standard : GB/T 18287-2000



The product is insured by Everest National Insurance Company

⑦